

Installation Instructions & Users Manual

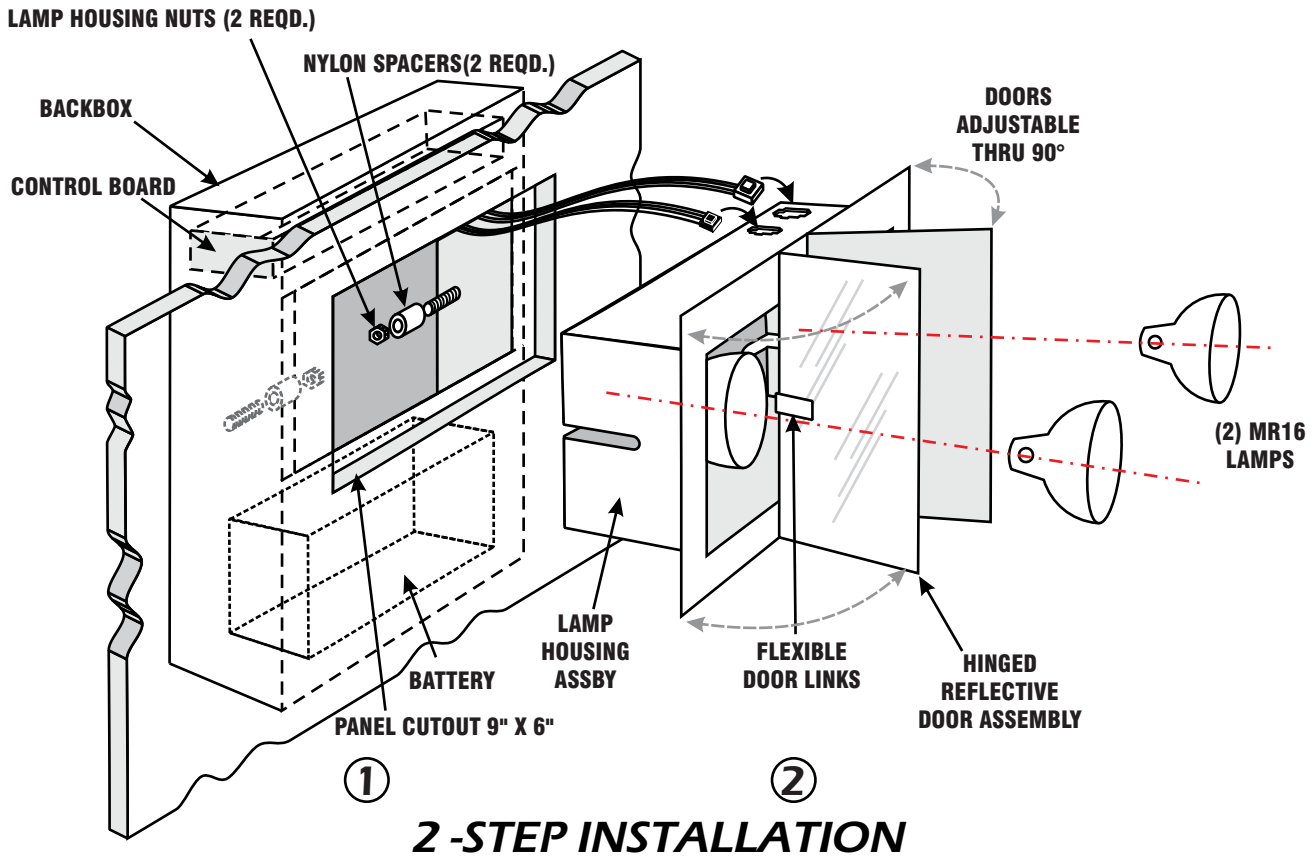

IMPORTANT SAFEGUARDS **READ AND FOLLOW ALL SAFETY INSTRUCTIONS**

Before connecting to power supply, **TURN OFF ELECTRICAL POWER AT CIRCUIT BREAKER OR FUSE**

Disconnect AC power before servicing.

Refer to wiring diagram for proper connections. All servicing should be performed by qualified personnel.

Consult your local building code for approved wiring and installation.

Do not use outdoors.

Do not use this equipment for other than intended use. Suitable for indoor damp locations.

Do not let power cords touch hot surfaces.

Do not mount near gas or electric heaters.

Mount and secure the fixture at a location and height to avoid ready access and tampering by unauthorized persons.

The use of accessory equipment is not recommended by the manufacturer and may cause an unsafe condition.



SAVE THESE INSTRUCTIONS

Backbox Installation

TOP MOUNT

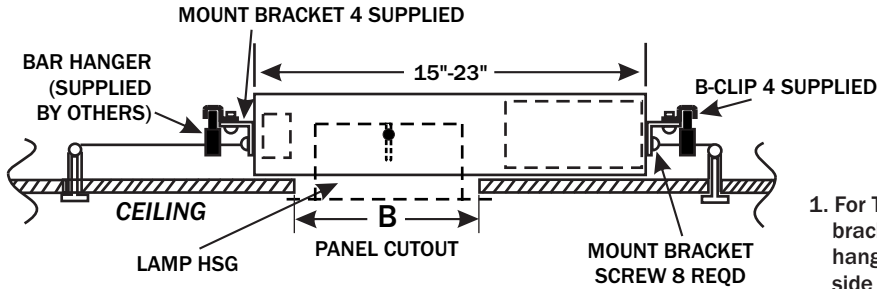

1. For T-Bar installations, rotate side bracket clips as required to fit T-Bar hangers. For masonry ceilings, attach side brackets to beam.

2. Refer to table on Page 2 and make cutout in ceiling panel.

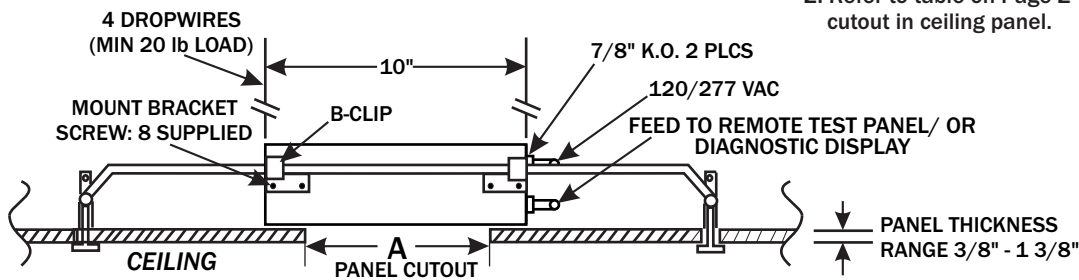

BACKBOX MUST BE FLUSH WITH TOP (INSIDE) SURFACE. IN MASONRY CEILINGS, SUPPORT WITH DROP WIRES AND FRAMING AS REQUIRED

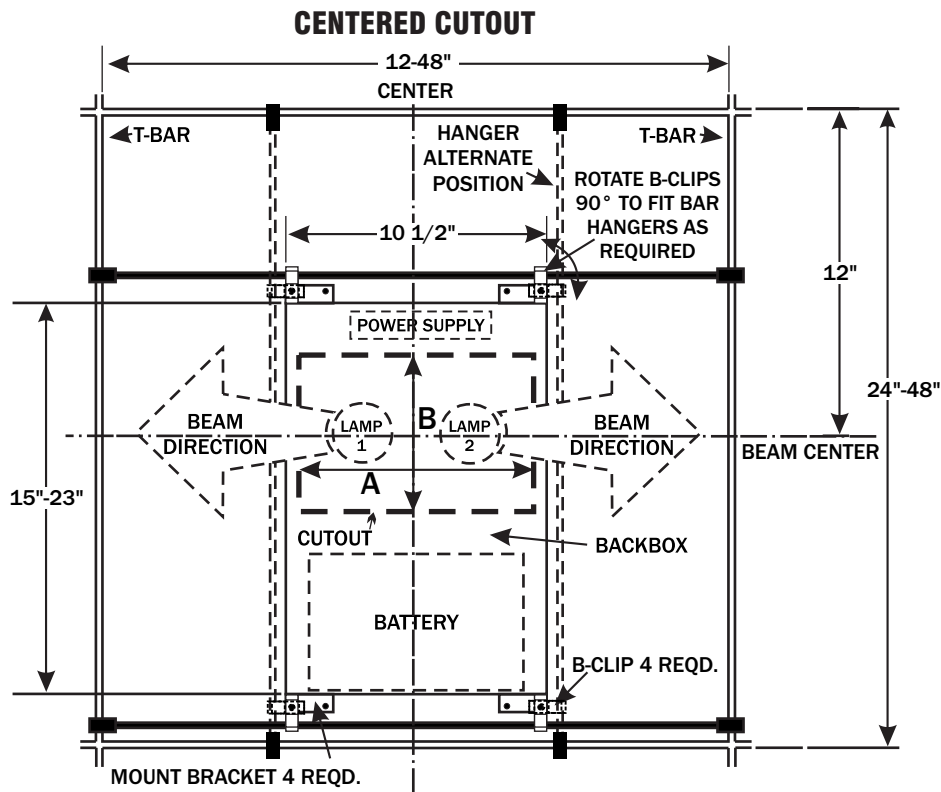

Backbox Installation

WALL MOUNT

1. Backbox mounts to stud on either left or right side. Select side to mount and attach upper and lower mount brackets with (4) #6-32 sheet metal screws provided.

2. See Table 1 below. Determine panel cutout location desired. Place backbox into position with face flush or just below stud face. Mark mount bracket hole locations.

NOTE: Upper bracket holes should be a minimum of 3" from upper joist or ceiling panel.

3. Drill pilot holes in stud at marked locations, and mount backbox in position with (4) mount screws installed firmly.

Both upper and lower mount brackets must be used. Fixture weight may be up to 50 lbs.

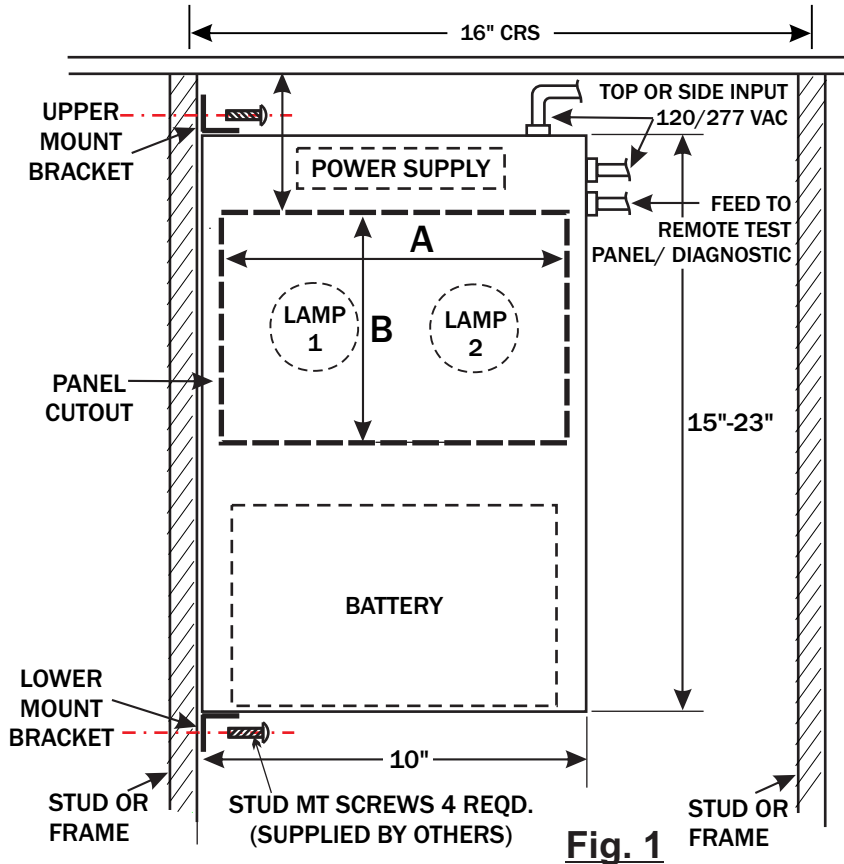

Fig. 1

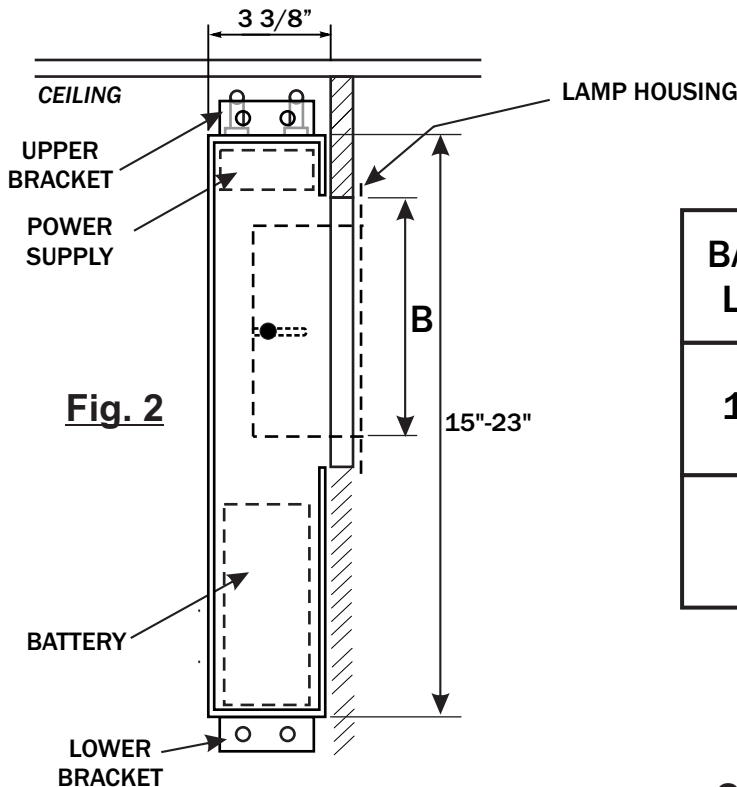

Fig. 2

Table 1

BACKBOX LENGTH	PANEL CUTOUT	
	A	B
15 1/2"	9"	6"
23"	9"	6 5/8"

Backbox Wiring Instructions

**BEFORE INSTALLING OR CONNECTING PRIMARY POWER WIRING,
DISCONNECT MAIN POWER AT CIRCUIT BREAKER.**

Polarized Connectors:

- ①: 5-wire 18 AWG: Lamp & Solenoid*
*6-Wire for Dual Battery Models
- ②: 6-wire 22 AWG: Test Panel
- ③: 2-wire 18 AWG: Battery

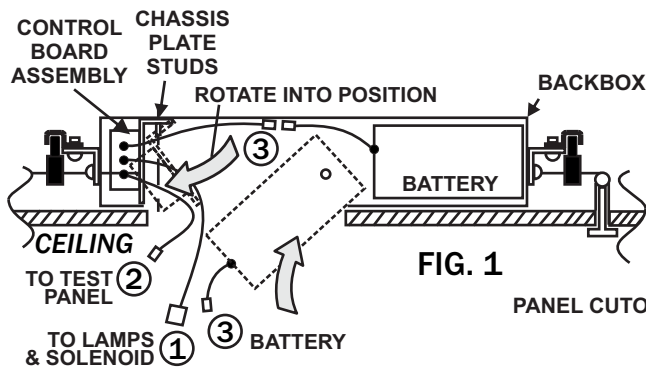

FIG. 1

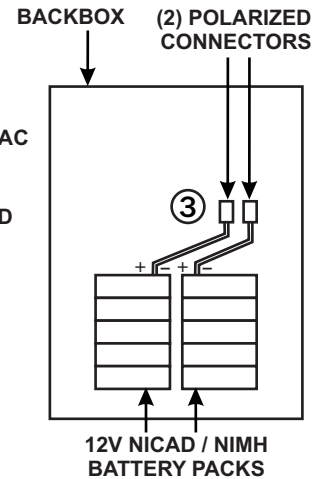
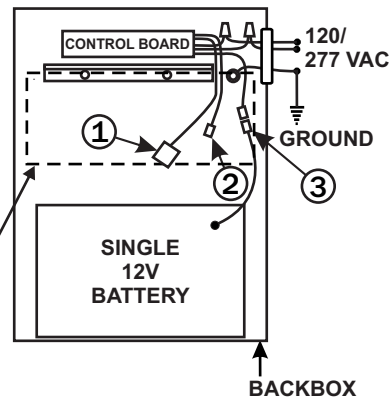

FIG. 2

BATTERY & CONTROL BOARD ASSEMBLY: WALL OR CEILING MOUNT

1. Route 120/277 VAC wiring into back box, install 7/8" connector and connect to control board with standard wire nuts as shown. Place GROUND connector on stud and tighten down. BLACK: 120-277 VAC WHITE: Neutral GREEN: Ground Position AC leads and wire nuts at side of control board clear of the output DC wiring.

NOTE: THIS DEVICE CONTAINS A MICROPROCESSOR TO CONTROL EMERGENCY LIGHTING. OPERATION AND CAN BE DISRUPTED BY EMI (ELECTRO-MAGNETIC INTERFERENCE) EMITTED BY CERTAIN TYPES OF LIGHTING OR OTHER ELECTRICAL EQUIPMENT. DO NOT CONNECT IN THE SAME CIRCUIT OR SHARE NEUTRAL WIRING WITH FREQUENCY-CHANGING DIMMING EQUIPMENT USED WITH HID FIXTURES.

2. For REMOTE TEST PANEL INSTALLATION, see Fig 7, Pg 7. Install standard vertical 2" x 3" switchbox in location for remote test panel display. Refer to Fig 7 wiring table and note maximum lengths for wiring 24-18 AWG. Run five wires and match color-codes RED, GREEN, YELLOW, BROWN & BLACK, from fixture to Test Panel.

NOTE: REMOTE TEST PANEL WIRING TRANSMITS DIGITAL DATA SIGNALS: IN ENVIRONMENTS WITH POSSIBLE EMI/RMI, THIS MAY REQUIRE SHIELDED CABLE SUCH AS ALPHA WIRE P/N 28-14/6. IF THE REMOTE TEST PANEL WIRING IS NOT INSTALLED, DISCONNECT THE REMOTE TEST WIRING PLUG ON THE CONTROL BOARD.

3. Install single or double battery into back box as shown.

Lamp Housing Assembly

Wall or Ceiling Mount

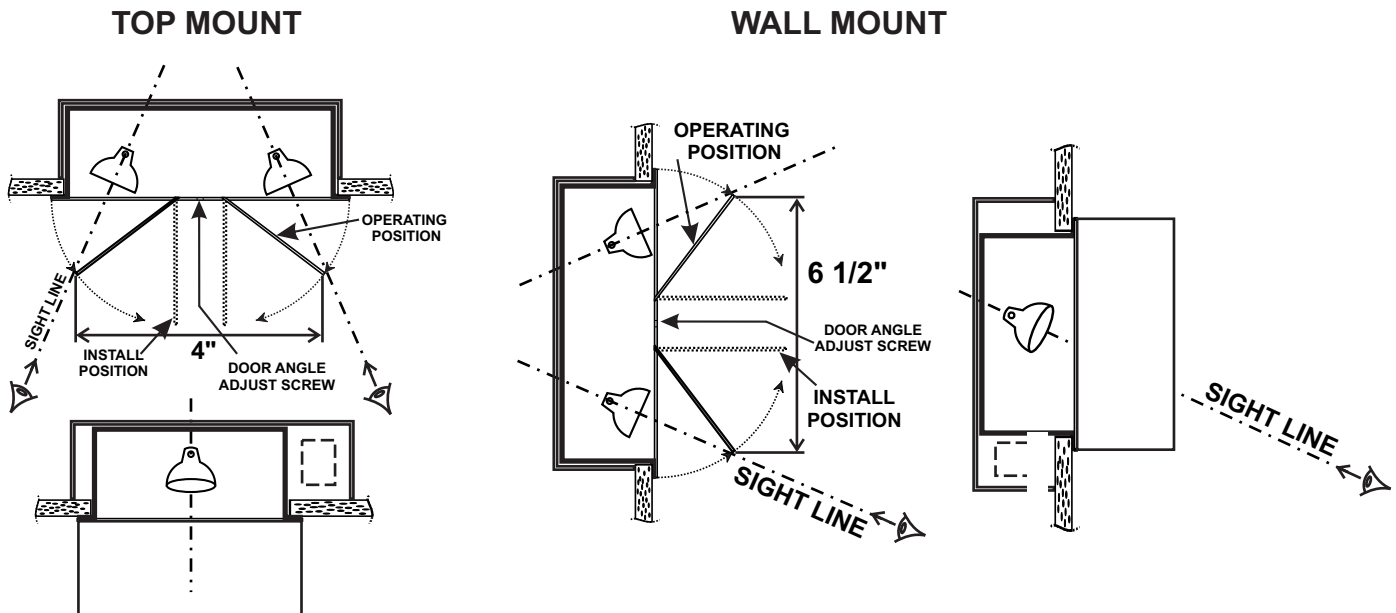

1. Open doors on lamp housing. Remove lamp boxes inside.
2. Plug male connectors from control board assembly into female connectors in lamp housing. Check nylon spacers are in place on two #8-32 studs in back box. Remove two #8-32 flange nuts, then slide lamp housing over studs until flange is flat against ceiling or wall finishing panel. Press housing flange firmly on to panel surface and tighten two #8-32 flange nuts supplied on studs.
3. Insert Mr16 lamps.
4. **STRIP OFF PLASTIC PROTECTOR FILM ON MIRROR DOORS BEFORE USE.**
5. **FOR CORRECT LIGHT DISTRIBUTION & DOOR OPERATION, SET DOOR ANGLE BY ADJUSTING STOP SCREW USING ALLEN KEY SUPPLIED, ROTATE COUNTER CLOCKWISE AS FOLLOWS:**

DIMENSION BETWEEN DOOR EDGES WHEN FULLY OPEN.
WALL MT6 1/2"
CEILING MT3 7/8"
6. With AC power connected, operate test switch, holding switch down until lamps illuminate, then release. Doors will close after about 10 second cool-down delay. See INITIAL BATTERY CHARGE PROCEDURE and LAMP & MIRROR SETTING PROCEDURE, Pg 6.

Setup & Operation

INITIAL BATTERY CHARGE PROCEDURE

1. When AC power is ON the GREEN AC power indicator light should be ON indicating battery charging.
2. Depress the EMERGENCY TEST SWITCH. After a delay of up to 3 seconds, the lamps will illuminate and doors will open. Release the test button. A timer circuit will energize and after a delay of 5-10 seconds, the doors will close.
3. Allow the battery to charge at least 12 hrs prior to lamp setup procedure. Full charge will be reached after 24 hours.

CAUTION: IF BATTERY IS CONNECTED TO CHARGER BOARD FOR A PROLONGED PERIOD WITHOUT AC POWER SUPPLIED, DAMAGE TO THE BATTERY CAN OCCUR AND WARRANTY WILL BE VOIDED.

TROUBLESHOOTING

FAULT	CORRECTION
GREEN AC Power Light OFF when AC power connected	Check AC power supply connections & circuit breaker.
Lamps fail to operate when Test Switch depressed or AC power is off	Allow minimum of 12 hrs battery charge, then repeat. If fault remains, check lamps are fully inserted in sockets. If still unlit, check battery voltage at connector 3. If voltage is below 10V, replace battery.
Doors fail to operate when Test Switch depressed or AC power is off	Manually open doors and confirm movement is free with no resistance. If movement is not free, check alignment of doors and hinges. Bent or buckled doors will require factory replacement. If movement is free, check terminal connectors on solenoid coil are in position and firm.
Doors do not stay closed when manually operated	Close doors electrically by depressing Test Switch for 2-3 seconds. After normal delay, doors will close fully.
Doors OPEN when AC power is ON	Check wire polarity connections to solenoid terminals as marked on frame: RED: POSITIVE, BLACK: NEGATIVE.
Doors OPEN and lamps turn ON at random when AC power is ON	(1) Verify branch circuit GROUND connection is certified to local codes. (2) Check for EMI (Electromagnetic Interference) or RMI (Radio Magnetic Interference) that may be generated near the fixtures or the branch circuit supply. <u>See Page 4.</u> If EMI/RMI is suspected, review the types of loads that may be included on the same branch circuit supplying the fixtures. Any devices emitting high EMI (such as dimming controls) may require a separate branch circuit. If problem continues, contact factory for EMI filtering options.
Doors fail to close after extended emergency operation	LAMP COOL DOWN: Following extended periods of emergency operation, particularly in ceiling installations where high ambient temperatures may exist, Halogen lamps may require a cool down period prior to doors closing. If doors do not close automatically after return of normal power, wait 15 minutes then momentarily de-energize and re-energize AC building power to reset and close the doors. This can be done by operating the fixture Push to Test Switch, or by cycling the branch AC circuit breaker.

Wiring Diagrams

**STANDARD TEST
PANEL DISPLAY**

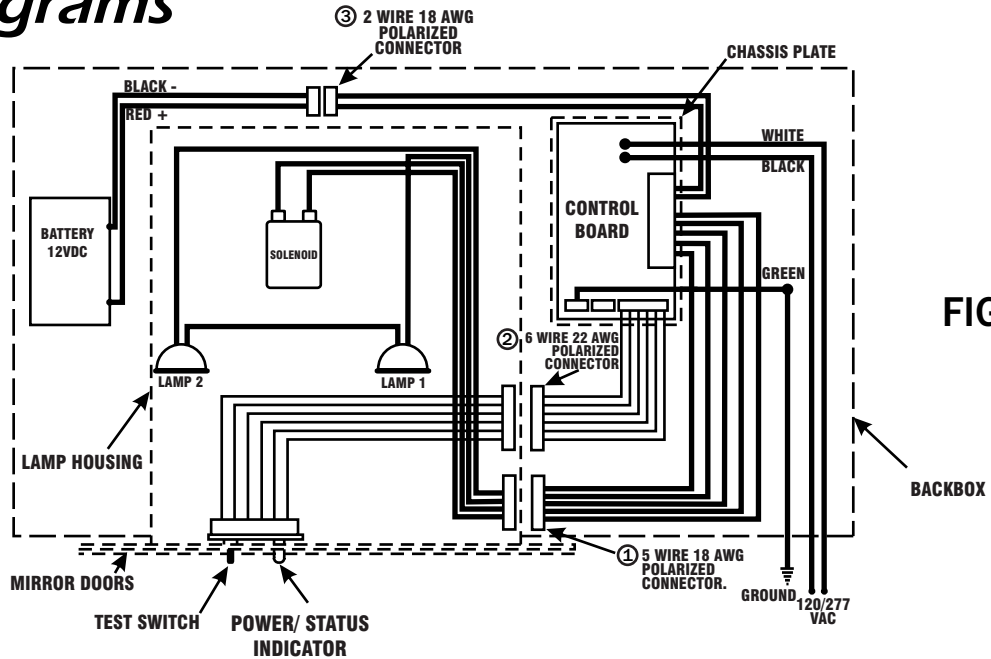

FIG. 6

**REMOTE TEST
PANEL DISPLAY**

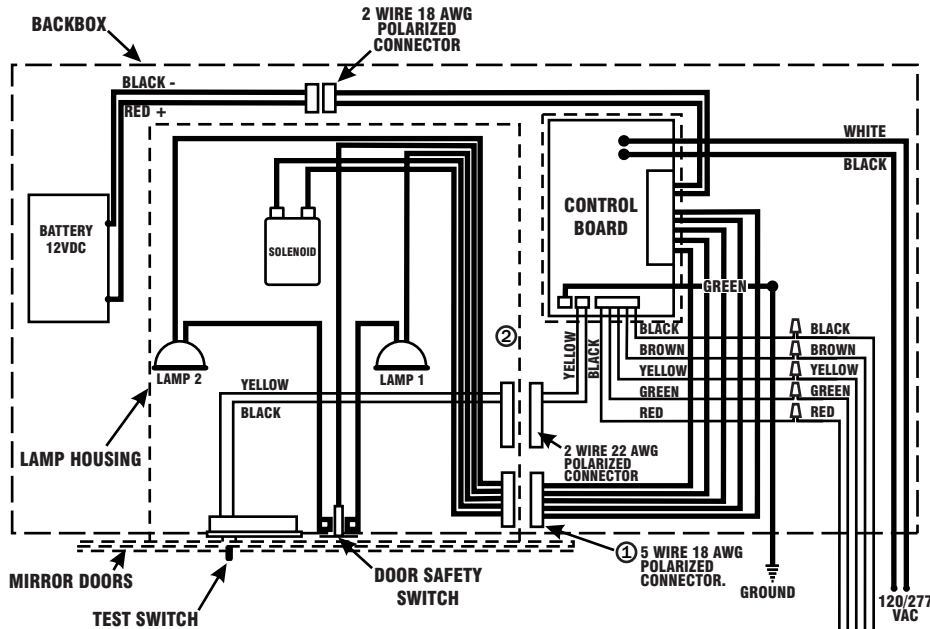
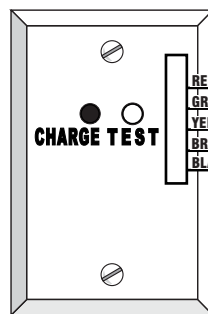

FIG. 7

WIRE AWG	MAX LENGTH FROM FIXTURE TO REMOTE PANEL
24	625 Ft
22	1000
20	1600
18	2560



**REMOTE TEST PANEL
STANDARD DISPLAY**

**WIRING BY OTHERS
TO MATCH COLOR
CODES SHOWN AT
CONTROL BOARD &
REMOTE PANEL**

**SEE TABLE BELOW
FOR WIRE LENGTHS**

Automatic Self- Test Diagnostics

NORMAL OPERATION

When the unit is functioning correctly, with AC power supplied, the diagnostic status indicator will be GREEN.

SELF-DIAGNOSTICS TESTING

In accordance with National Fire Protection Association Life Safety Code 101 NFPA 101), emergency lighting systems should be tested at least monthly to determine all components are operational, and the equipment should comply with UL Standard 924. In addition, the Code requires that every 12 months the unit must be tested in full rated emergency condition (minimum 1 ½ hrs battery operation). The self-diagnostics and self-testing system installed in this product will automatically perform tests to satisfy these requirements.

INITIALIZATION

1. AFTER THE BATTERY AND AC SUPPLY ARE CONNECTED, THE SYSTEM BEGINS OPERATION IN THE DIAGNOSTICS MODE. EVERY 60 SECONDS THE FOLLOWING FUNCTIONS ARE AUTOMATICALLY TESTED:

- BATTERY CONNECTION
- LAMP CONNECTION
- CHARGER TRANSFER SWITCH

2. EVERY 28 DAYS, THE BATTERY DISCHARGE RATE IS ANALYZED. REDUCED BATTERY CAPACITY WILL BE DISPLAYED (SEE TABLE BELOW).

3. EVERY 12 MONTHS, THE SYSTEM WILL AUTOMATICALLY OPERATE UNDER FULL EMERGENCY OPERATION FOR 9 MINUTES (OR LONGER IF BATTERY CAPACITY IS SO SPECIFIED). ANY REDUCED BATTERY CAPACITY OR OTHER FAULTS WILL BE DISPLAYED (SEE TABLE BELOW).

NOTE: LIFE SAFETY CODES REQUIRE THAT EACH ANNUAL TEST IS RECORDED AT THE SITE IN WRITING; RECORD DATE OF ANNUAL TEST AND UPDATE EVERY 12 MTHS.

MANUAL TEST:

A manual test can be performed at any time by pressing the TEST SWITCH. The doors will open and the lamps will illuminate as long as the test switch is held down. Any reduction in battery capacity will be detected and the status indicator will indicate BATTERY FAILURE. After the Test Switch is released, the lamps will turn off and after a cool-down delay of about 5-10 seconds, the doors will close.

STATUS	LED DISPLAY
NORMAL FULL CHARGE	GREEN ON
NORMAL FAST RECHARGE	ORANGE ON
FAILED BATTERY	RED DOUBLE FLASH
FAILED LAMP (1 & 2)	GREEN FLASH
FAILED TRANSFER	ORANGE FLASH
FAILED CHARGER	RED FLASH
ANNUAL TEST PASS	RED- GREEN FLASH